

User's Manual

FlexScan® SX2262W SX2462W

Color LCD Monitor

Important

Please read PRECAUTIONS, this User's Manual and Setup Guide (separate volume) carefully to familiarize yourself with safe and effective usage.

-
- Please read the Setup Guide (separate volume)
 - The latest User's Manual is available for download from our site:
<http://www.eizo.com>
-



[Location of the Caution Statements]

Ex. SX2462W

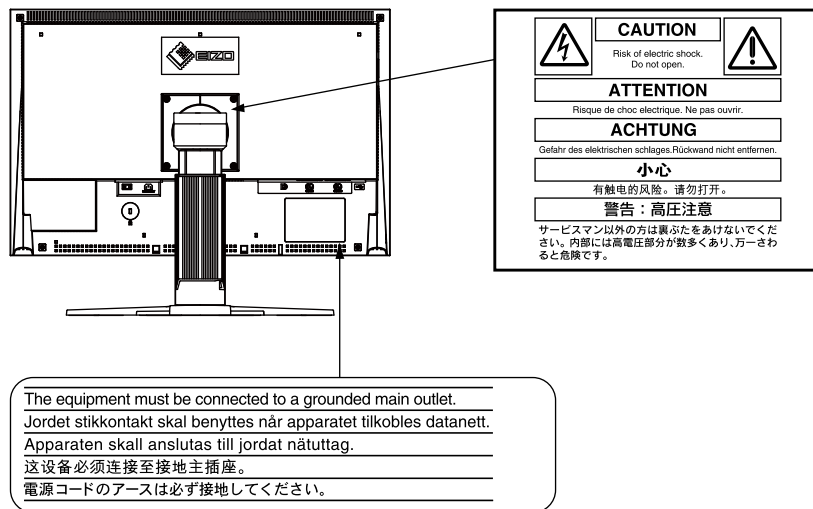

This product has acquired TCO standard that relates to safety, ergonomics, environment and so forth of office equipment. For overview of the TCO, refer to our website.

<http://www.eizo.com>

Product specification may vary with sales areas.

Confirm the specification in the manual written in language of the region of purchase.

Copyright© 2009 EIZO NANA O CORPORATION All rights reserved.

No part of this manual may be reproduced, stored in a retrieval system, or transmitted, in any form or by any means, electronic, mechanical, or otherwise, without the prior written permission of EIZO NANA O CORPORATION.

EIZO NANA O CORPORATION is under no obligation to hold any submitted material or information confidential unless prior arrangements are made pursuant to EIZO NANA O CORPORATION's receipt of said information.

Although every effort has been made to ensure that this manual provides up-to-date information, please note that EIZO monitor specifications are subject to change without notice.

Apple and Macintosh are registered trademarks of Apple Inc.

VGA is a registered trademark of International Business Machines Corporation.

Windows and Windows Vista are registered trademarks of Microsoft Corporation.

The round gothic bold bit map font used for this product is designed by Ricoh.

DisplayPort icon and VESA are trademarks and registered trademarks of Video Electronics Standards Association.

PowerManager and UniColor Pro are trademarks of EIZO NANA O CORPORATION.

EIZO, EIZO Logo, FlexScan, i-Sound and ScreenManager are registered trademarks of EIZO NANA O CORPORATION in Japan and other countries.



Notice for this monitor

Aside from creating documents, viewing multimedia content, and other general purposes, this product is also suited to applications such as graphics creation and digital photo processing, where accurate color reproduction is a priority.

This product has been adjusted specifically for use in the region to which it was originally shipped. If the product is used outside the region, it may not operate as specified in the specifications.

This product may not be covered by warranty for uses other than those described in this manual.

The specifications noted in this manual are only applicable for power cords and signal cables specified by us.

Use optional products manufactured or specified by us with this product.

As it takes about 30 minutes for the performance of electrical parts to stabilize, adjust the monitor 30 minutes or more after the monitor power has been turned on.

In order to suppress the luminosity change by long-term use and to maintain the stable luminosity, use of a monitor in lower brightness is recommended.

When the screen image is changed after displaying the same image for extended periods of time, an afterimage may appear. Use the screen saver or power save function to avoid displaying the same image for extended periods of time.

Periodic cleaning is recommended to keep the monitor looking new and to prolong its operation lifetime. (Refer to “[Cleaning](#)” on the next page.)

The LCD panel is manufactured using high-precision technology. However, missing pixels or lit pixels may appear on the LCD panel, this is not malfunction. Percentage of effective pixels : 99.9994% or higher.

The backlight of the LCD panel has a fixed life span. When the screen becomes dark or begins to flicker, please contact your dealer.

Do not press on the panel or edge of the frame strongly, as this may result in the display malfunction, such as the interference patterns, etc. If pressure is continually applied to the LCD panel, it may deteriorate or damage your LCD panel. (If the pressure marks remain on the LCD panel, leave the monitor with a white or black screen. The symptom may disappear.)

Do not scratch or press on the panel with any sharp objects, such as a pencil or pen as this may result in damage to the panel. Do not attempt to brush with tissues as this may scratch the LCD panel.

When the monitor is cold and brought into a room or the room temperature goes up quickly, dew condensation may occur inside and outside the monitor. In that case, do not turn the monitor on and wait until dew condensation disappears, otherwise it may cause some damages to the monitor.

Cleaning

Attention

- Never use any solvents or chemicals, such as thinner, benzene, wax, alcohol, and abrasive cleaner, which may damage the cabinet or LCD panel.

NOTE

- Optional ScreenCleaner is recommended for cleaning the panel surface.

● **LCD Panel**

- Clean the LCD panel with a soft cloth such as cotton cloth or lens cleaning paper.
- Remove persistent stains gently with a cloth dampened with a little water, and then clean the LCD panel again with a dry cloth for better finishing.

● **Cabinet**

- Clean the cabinet with a soft cloth dampened with a little mild detergent.

To use the monitor comfortably

- An excessively dark or bright screen may affect your eyes. Adjust the brightness of the monitor according to the environmental conditions.
- Staring at the monitor for a long time tires your eyes. Take a 10-minute rest every hour.

CONTENTS

Cover	1	3-3. Setting the EIZO Logo Display [Logo]	26
Notice for this monitor	3	3-4. Setting Orientation [Orientation]	26
CONTENTS	5	● To set the orientation of the Adjustment menu .	26
Chapter 1 Introduction	6	3-5. Setting Language [Language]	27
1-1. Features	6	3-6. Setting the Display Position of the Adjustment Menu [Menu Position]	27
1-2. Controls and Functions	7	3-7. Enable/Disable DDC/CI communication	27
1-3. Utility Disk	8	3-8. Enable/Disable Auto Sharpness [Auto Sharpness]	28
● Disk contents and software overview	8	3-9. Restoring the Default Setting	28
● To use ScreenManager Pro for LCD/ EIZO ScreenSlicer	8	● To reset color adjustment values [Color Reset] .	28
1-4. Basic Operation and Functions	9	● To reset all adjustments to the factory default settings [All Reset]	28
Basic operation of Adjustment menu	9	Chapter 4 Power Saving Function	29
Showing Button Guide	10	4-1. Setting the Power Saving [Power Save]	29
Functions	11	4-2. Setting Power Indicator [Power Indicator]	29
Chapter 2 Adjusting Screen	12	4-3. Setting Monitor's Automatic Brightness Adjustment [Auto EcoView]	30
2-1. Setting Screen Resolution	12	4-4. Setting the automatic power off function [Eco Timer]	30
Compatible Resolutions/Frequencies	12	Chapter 5 Troubleshooting	31
Setting Resolution	13	Chapter 6 Reference	34
● Windows 7	13	6-1. Attaching an Arm	34
● Windows Vista	13	6-2. Connecting More than Two PCs to the Monitor	35
● Windows XP	13	● To switch the input signal	35
● Mac OS X	13	● To set input signal selection [Input Selection] ..	36
2-2. Displaying Screen Correctly	14	6-3. Making Use of USB (Universal Serial Bus)	37
Digital Input	14	● Required System Environment	37
Analog Input	14	● Connection Procedure (Setup of USB Function) ..	37
2-3. Color Adjustment	18	6-4. Displaying Monitor Information	38
● To select the display mode (FineContrast)	18	● Displaying monitor information by pressing ⓘ ..	38
● To perform advanced adjustments	18	● Displaying signal information [Signal Info]	38
● Adjustment items in each mode	19	● Displaying monitor information [Monitor Info]	38
● To adjust the brightness [Brightness]	20	6-5. Specifications	39
● To adjust the contrast [Contrast]	20	6-6. Glossary	45
● To adjust the color temperature [Temperature] ..	20	6-7. Preset Timing	47
● To adjust the gamma value [Gamma]	21	TCO'03	48
● To adjust the hue [Hue]	21	FCC Declaration of Conformity	49
● To adjust the color saturation [Saturation]	21	Hinweise zur Auswahl des richtigen Schwenkarms für Ihren Monitor	50
● Enable/Disable Contrast Enhancer [Contrast Enhancer]	22	Hinweis zur Ergonomie	50
● To enhance the outline of the image [Outline Enhancer]	22		
● To adjust the gain value [Gain]	22		
● To adjust six colors [6 Colors]	23		
2-4. Displaying Lower Resolutions	24		
● To change screen size [Screen Size]	24		
Chapter 3 Setting Monitor	25		
3-1. Enabling/Disabling Mode Selection [Mode Preset]	25		
3-2. Locking Buttons [Key Lock]	25		

Chapter 1 Introduction

Thank you very much for choosing an EIZO Color Monitor.

1-1. Features

- 22" wide format LCD (SX2262W) / 24" wide format LCD (SX2462W)
 - Resolution 1920 dots x 1200 lines
 - Applicable to DisplayPort (applicable to 8 bit or 10 bit, not applicable to audio signals)
 - 3 signal input terminals (DVI-I x 2, DisplayPort x 1)
 - FineContrast function for selecting an optimal display mode
"2-3. To select the display mode (FineContrast)" (page 18)
 - The software "ScreenManager Pro for LCD" to adjust the screen using the mouse and keyboard is included
"1-3. Utility Disk" (page 8)
 - Color Vision Deficiency Simulation Software "UniColor Pro" supported
(This software can be downloaded from <http://www.eizo.com>)
 - Power saving function
Suppressing the power consumption* reduces the carbon dioxide emissions. This product is equipped with power saving function.
 - Power Consumption when main power switch is Off: 0W
Equipped with main power switch.
Turning off the main power switch completely shuts off power supply to the monitor while the monitor is not used.
 - Auto EcoView function
The sensor on the front side of the monitor detects the environmental brightness to adjust the screen brightness automatically and comfortably.
Excessively high brightness may lead a damage to the natural environment as well as to your eyes. Suppressing the excessively high brightness will be helpful to reduce the power consumption and the damage to your eyes.
"4-3. Setting Monitor's Automatic Brightness Adjustment [Auto EcoView]" (page 30)
 - EcoView Index function
This indicator shows the power saving ratio, power reduction and CO2 reduction as a result of the brightness of the monitor. You can realize the power consumption reduction by taking consideration in the ratio of power saving.
"6-4. Displaying Monitor Information" (page 38)
 - HDCP (High-bandwidth Digital Content Interface)
 - Portrait/Landscape display available (rotate 90 degrees clockwise)
- * Reference values:
- SX2262W
Maximum power consumption: 80W (Luminance Max., at default settings)
Standard power consumption: 45W (100VAC, Luminance 120cd/m², at default settings)
Standard power consumption: 45W (200VAC, Luminance 120cd/m², at default settings)
 - SX2462W
Maximum power consumption: 85W (Luminance Max., at default settings)
Standard power consumption: 48W (100VAC, Luminance 120cd/m², at default settings)
Standard power consumption: 47W (200VAC, Luminance 120cd/m², at default settings)

NOTE

- This monitor supports the Portrait/Landscape display. This function allows you to change the orientation of the Adjustment menu when using the monitor screen in vertical display position. (Refer to "To set the orientation of the Adjustment menu [Orientation]" on page 26.)
 - For using the monitor with "Portrait" position, the graphics board supporting portrait display is required. When placing the monitor in a "Portrait" position, settings of your graphics board need to be changed. Refer to the manual of the graphics board for details.
-

1-2. Controls and Functions

Ex. SX2462W

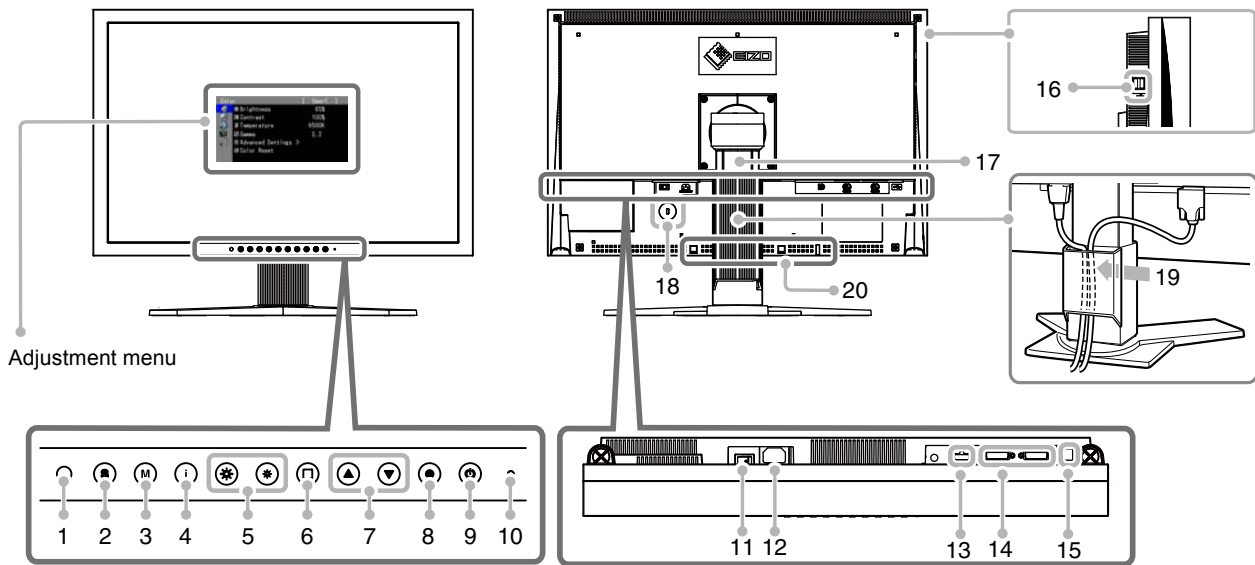

1	Sensor	Detects ambient brightness. Auto EcoView function. (page 30)
2	(S) button	Switches input signals for display when more than two PCs are connected to the monitor. (page 35)
3	(M) button	Allows you to switch the FineContrast mode. (page 18)
4	(i) button	Information regarding monitor power saving (page 38)
5	(*)(* button	Adjusts the brightness.(page 20)
6	(□) button	Cancels the adjustment/setting or exit the adjustment menu.(page 9)
7	(▲)(▼) button	Chooses an adjustment item or increases/decreases adjusted values for advanced adjustments using the Adjustment menu.
8	(●) button	Displays the Adjustment menu, determines an item on the menu screen, and saves values adjusted.(page 9)
9	(⏻) button	Turns the power on or off.
10	Power indicator	Indicates monitor's operation status. Blue: Operating Orange: Power saving Off: Power off
11	Main Power switch	Turns the main power on or off.
12	Power connector	Connects the power cord.
13	Input signal connectors	DisplayPort Connector x 1
14	Input signal connectors	DVI-I Connector x 2 (Left : SIGNAL1 / Right : SIGNAL2)
15	USB port (Up)	Connects the USB cable to use the software that needs USB connection, or to use USB Hub function.(page 37)
16	USB port (Down)	Connects a peripheral USB device.
17	Stand	Used to adjust the height and angle of the monitor screen.
18	Security lock slot	Complies with Kensington's MicroSaver security system.
19	Cable holder	Covers the monitor cables.
20	Option speaker (i-Sound L3) mounting holes	Used to attach the option speaker (i-Sound L3).

1-3. Utility Disk

An “EIZO LCD Utility Disk” (CD-ROM) is supplied with the monitor. The following table shows the disk contents and the overview of the software programs.

● Disk contents and software overview

The disk includes application software programs for adjustment, and User’s Manual. Refer to “Readme.txt” file on the disk for software startup procedures or file access procedures.

Item	Overview	OS
A “Readme.txt” file		
Screen adjustment pattern files	Used when adjusting the image of the analog signal input manually.	
ScreenManager Pro for LCD * WindowMovie Checker Software	A software for adjusting the screen using the mouse and keyboard. Connect the monitor to the PC with the supplied USB cable before installation. WindowMovie is a function of ScreenManager Pro for LCD. For more information, refer to the User’s Manual of ScreenManager Pro for LCD on the disk.	Windows XP/Vista
EIZO ScreenSlicer	A software that divides a screen and lays out multiple windows efficiently.	Windows XP/Vista/7
User’s Manual of this monitor (PDF file)		

● To use ScreenManager Pro for LCD/EIZO ScreenSlicer

For the installation and use of ScreenManager Pro for LCD/EIZO ScreenSlicer, refer to the respective User’s Manual on the disc.

To adjust the monitor using ScreenManager Pro for LCD, connect a PC to the monitor with the supplied USB cable. For more information, refer to the “Chapter 6 6-3. Making Use of USB (Universal Serial Bus)” ([page 37](#)).

1-4. Basic Operation and Functions

Basic operation of Adjustment menu

1 Displaying Adjustment Menu

Press **○**.

The adjustment menu appears.

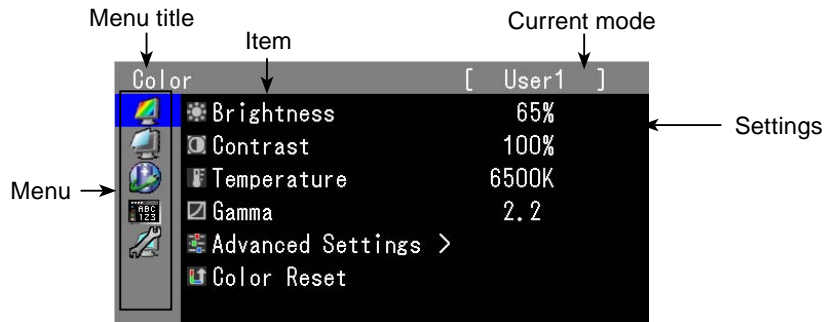

2 Adjusting/Setting

1. Choose a menu to adjust/set with **▲▼**, and press **○**.

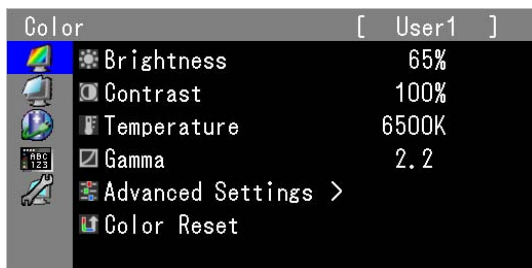

2. Choose an item to adjust/set with **▲▼**, and press **○**.

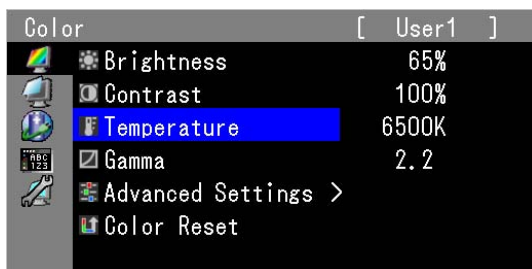

3. Adjust/set the selected item with **▲▼**, and press **○**.

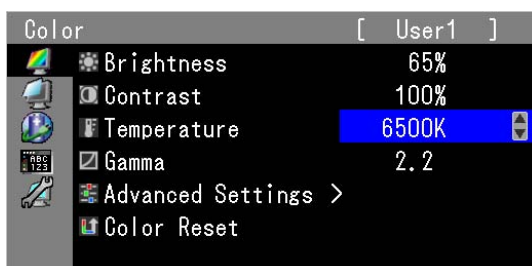

3 Exiting

Press **Ⓞ** a few times.

The adjustment menu finishes.

Showing Button Guide

Press the front buttons (except  button), the button guide appears above the button. (When using the monitor with "Portrait" position, the button guide appears next to the button.)

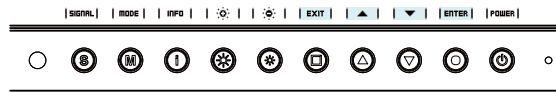





NOTE

- The button guide will continue to appear while the Adjustment menu or Mode menu is showing.
 - The button guide is displayed differently depending on the selected menu or status.
-

Functions

The following table shows all the Adjustment menu's adjustment and setting menus.

Main Menu	Item	Adjusting/Setting	
Color 	Brightness	"2-3. Color Adjustment" (page 18)	
	Contrast		
	Temperature		
	Gamma		
	Advanced Settings		Hue
			Saturation
			Contrast Enhancer
			Outline Enhancer
			Gain
		6 Colors	
	Color Reset	"3-9. Restoring the Default Setting" (page 28)	
Screen 	Screen Size	"2-4. Displaying Lower Resolutions" (page 24)	
	Analog Adjustment	Auto Adjustment	"2-2. Displaying Screen Correctly" (page 14)
		Range Adjustment	
		Clock	
		Phase	
		Hor.Position	
		Ver.Position	
PowerManager 	Power Save	"4-1. Setting the Power Saving" (page 29)	
	Auto EcoView	"4-3. Setting Monitor's Automatic Brightness Adjustment" (page 30)	
	Power Indicator	"4-2. Setting Power Indicator" (page 29)	
	Eco Timer	"4-4. Setting the automatic power off function" (page 30)	
Menu Settings 	Language	"3-5. Setting Language" (page 27)	
	Orientation	"3-4. Setting Orientation" (page 26)	
	Menu Position	"3-6. Setting the Display Position of the Adjustment Menu" (page 27)	
Tools 	Input Selection	"6-2. Connecting More than Two PCs to the Monitor" (page 35)	
	Auto Sharpness	"3-8. Enable/Disable Auto Sharpness" (page 28)	
	Mode Preset	"3-1. Enabling/Disabling Mode Selection" (page 25)	
	Signal Info	"6-4. Displaying Monitor Information" (page 38)	
	Monitor Info		
	All Reset	"3-9. Restoring the Default Setting" (page 28)	

* The adjusting/setting function on the <Color> menu depend on the selected Color mode (page 19). The above table shows the sub menus when the "User1-3" mode is selected (See "2-3. Color Adjustment" (page 18)).

Chapter 2 Adjusting Screen

2-1. Setting Screen Resolution

Compatible Resolutions/Frequencies

The monitor supports the following resolutions.

Analog Input

Resolution	Applicable signal	Frequency	Dot Clock
640 × 480	VGA	60 Hz	170 MHz (Max.)
720 × 400	VGA TEXT	70 Hz	
800 × 600	VESA	60 Hz	
1024 × 768	VESA	60 Hz	
1280 × 960	VESA	60 Hz	
1280 × 1024	VESA	60 Hz	
1600 × 1200	VESA	60 Hz	
1680 × 1050	VESA CVT	60 Hz	
1920 × 1200*	VESA CVT RB	60 Hz	

Digital Input (DVI-I/DisplayPort)

Resolution	Applicable signal	Frequency	Dot Clock
640 × 480	VGA	60 Hz	164.5 MHz (Max.)
720 × 400	VGA TEXT	70 Hz	
800 × 600	VESA	60 Hz	
1024 × 768	VESA	60 Hz	
1280 × 960	VESA	60 Hz	
1280 × 1024	VESA	60 Hz	
1600 × 1200	VESA	60 Hz	
1680 × 1050	VESA CVT, VESA CVT RB	60 Hz	
1920 × 1200*	VESA CVT RB	60 Hz	

A graphics board in conformance with VESA standard is required.

* Recommended resolution (Set this resolution)

Setting Resolution

When you connect the monitor to the PC and find that the resolution is improper, or when you want to change the resolution, follow the procedure below.

● Windows 7

1. Right-click the mouse anywhere on the desktop except for icons.
2. From the displayed menu, click “Screen resolution”.
3. On the "Screen Resolution" dialog, select the monitor .
4. Click "Resolution" to select the desired resolution.
5. Click the [OK] button.
6. When a confirmation dialog is displayed, click [Keep changes].

● Windows Vista

1. Right-click the mouse anywhere on the desktop except for icons.
2. From the displayed menu, click “Personalize”.
3. On the “Personalization” window, click “Display Settings”.
4. On the “Display Settings” dialog, select the “Monitor” tab and select desired resolution in the “Resolution” field.
5. Click the [OK] button.
6. When a confirmation dialog is displayed, click [Yes].

● Windows XP

1. Right-click the mouse anywhere on the desktop except for icons.
2. From the displayed menu, click “Properties”.
3. When the “Display Properties” dialog is displayed, click the “Settings” tab and select desired resolution for “Screen resolution” under “Display”.
4. Click the [OK] button to close the dialog.

● Mac OS X

1. Select “System Preferences” from the Apple menu.
2. When the “System Preferences” dialog is displayed, click “Displays” for “Hardware”.
3. On the displayed dialog, select the “Display” tab and select desired resolution in the “Resolutions” field.
4. Your selection will be reflected immediately. When you are satisfied with the selected resolution, close the window.

2-2. Displaying Screen Correctly

Digital Input

When digital signals are input, images are displayed correctly based on the preset data of the monitor. When performing advanced adjustment, see “2-3. Color Adjustment” (page 18) and subsequent pages.

Analog Input

Attention

- Wait 30 minutes or more from monitor power on before starting adjustments.
(Allow the monitor to warm up for at least 30 minutes before making adjustments.)

The monitor screen adjustment is used to suppress flickering of the screen or adjust screen position and screen size correctly according to the PC to be used.

The Self Adjust function works when all of the following conditions are satisfied.

- When a signal is input into the monitor for the first time or when the resolution or Vertical/Horizontal Frequency not displayed before is set
- When signals with the vertical resolution over 480 are input



If the screen is not displayed correctly even after performing the Self Adjust operation, adjust the screen according to the procedures on the following pages to use the monitor comfortably.

[Adjustment Procedure]

1 Perform the auto adjustment.

- To adjust flickering, screen position, and screen size automatically [Auto Adjustment]

Procedure

1. Choose <Screen> from the Adjustment menu, and press .
2. Choose <Analog Adjustment> from the <Screen> menu, and press .
3. Choose <Auto Adjustment>, and press .

The auto adjustment function works (the message “In Progress” appears) to correctly adjust the flickering, screen position, and screen size correctly.

When the auto adjustment is completed, a message appears. Select “OK” to confirm the new settings or “Cancel” to restore the previous settings, and press .

Attention

- This function works correctly when an image is fully displayed over the Windows or Macintosh display area. It does not work properly when an image is displayed only on a part of the screen (command prompt window, for example) or when a black background (wallpaper, etc.) is in use.
- This function does not work correctly with some graphics boards.

If the screen is not displayed correctly even after adjusting in step 1 above, perform the adjustments according to the procedures on the following pages. When the screen is displayed correctly, go to [step 5](#) “To adjust color gradation automatically [Range Adjustment]”.

2 Prepare the display pattern for the analog display adjustment.

Load the “EIZO LCD Utility Disk” to your PC, and then open the “Screen adjustment pattern files”.

NOTE

- For details and instructions on opening the “Screen adjustment pattern files”, refer to the “Readme.txt” file.

3 Perform the auto adjustment again with the analog screen adjustment pattern displayed.

● To adjust flickering, screen position, and screen size automatically [Auto Adjustment]

Procedure

1. Display Pattern 1 of the “Screen adjustment pattern files” in full screen on the monitor.

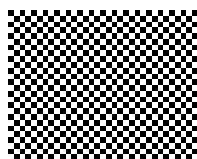

2. Choose <Screen> from the Adjustment menu, and press .
3. Choose <Analog Adjustment> from the <Screen> menu, and press .
To proceed with the subsequent adjustments, select an item in <Analog Adjustment> of the <Screen> menu.
4. Choose <Auto Adjustment>, and press .
The auto adjustment function works (the message “In Progress” appears) to adjust the flickering, screen position, and screen size correctly.
When the auto adjustment is completed, a message appears. Select “OK” to confirm the new settings or “Cancel” to restore the previous settings, and press .







If the screen is not displayed correctly even after adjusting in step 3 above, perform the adjustments according to the procedures on the following pages. When the screen is displayed correctly, go to [step 5](#) “To adjust color gradation automatically [Range Adjustment]”.

4 Perform advanced adjustments for the following using the <Screen> menu of the <Analog Adjustment>.

Adjust the clock, phase and position, in this order.

● To eliminate vertical bars [Clock]





Procedure

1. Choose <Clock> from the <Analog Adjustment> menu, and press .
2. Adjust the clock with  or .
Press  slowly so as not to miss the adjustment point.
3. Press  to exit the adjustment.
When blurring, flickering or bars appear on the screen after adjustment, proceed to [Phase] to remove flickering or blurring.



● Remove flickering or blurring [Phase]

Procedure

1. Choose <Phase> from the <Analog Adjustment> menu, and press .
2. Adjust the phase with  or .
3. Press  to exit the adjustment.

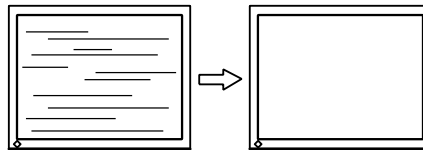

Attention





- Flickering or blurring may not be eliminated depending on your PC or graphics board.

● To correct screen position [Hor.Position] [Ver.Position]

NOTE

- Since the number of pixels and the pixel positions are fixed on the LCD monitor, only one position is provided to display images correctly. The position adjustment is made to shift an image to the correct position.

Procedure

1. Choose <Hor.Position> or <Ver.Position> from the <Analog Adjustment> menu, and press .
2. Adjust the position with  or .
3. Press  to exit the adjustment.
When vertical bars appear on the screen after adjustment, go back to “To eliminate vertical bars [Clock]”.
(Clock → Phase → Position)

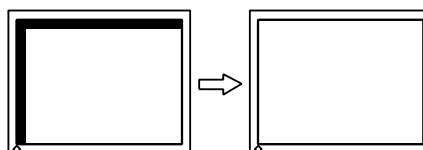

5 Adjust the color gradation.

● To adjust color gradation automatically [Range Adjustment]

Every color gradation (0 to 255) can be displayed by adjusting the signal output level.

Procedure

1. Display Pattern 2 in full screen on the monitor using the “Screen adjustment pattern files”.

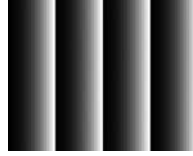

2. Choose <Range Adjustment> from the <Analog Adjustment> menu, and press .

The color gradation is adjusted automatically.

When the auto adjustment is completed, a message appears. Select “OK” to confirm the new settings or “Cancel” to restore the previous settings, and press .

3. Close the Pattern 2.

2-3. Color Adjustment

● To select the display mode (FineContrast)

FineContrast allows you to select easily the adequate mode suitable for the monitor's application.

FineContrast mode

Mode	Purpose
1-User1	Available for the color settings according to your preference.
2-User2	
3-User3	
4-Text	Suitable for displaying texts for word processing or spreadsheets.
5-Picture	Suitable for displaying images such as photos or picture images.
6-Movie	Suitable for playing back animated images.
7-sRGB	Suitable for color matching with sRGB compatible peripherals.

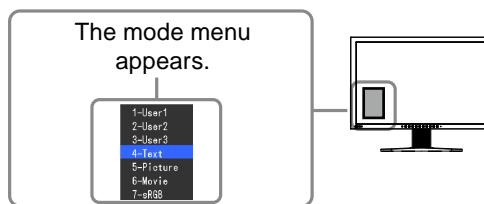

Procedure

1. Press **(M)**.
Mode menu appears at the lower left of the screen.
2. The mode among the list is highlighted in turn each time **(M)** is pressed.
You can switch the current mode with **(▲)** or **(▼)** while the mode menu is being displayed.



NOTE

- The Adjustment menu and the Mode menu cannot be displayed at the same time.
- You can disable a specific mode to be selected. For more information, refer to “3-1. Enabling/Disabling Mode Selection” (page 25).
- “ScreenManager Pro for LCD” allows you to select the FineContrast mode automatically according to the application used. (Refer to “Chapter 3 Auto FineContrast” on the User’s Manual for “ScreenManager Pro for LCD”.)

● To perform advanced adjustments

The <Color> menu of the Adjustment menu allows you to set and save the independent color adjustment for each mode.

Attention

- Wait 30 minutes or more from monitor power on before starting the color adjustment.
(Allow the monitor to warm up for at least 30 minutes before making adjustments.)
- Perform the range adjustment first when adjusting color for analog input signals.
(Refer to “To adjust color gradation automatically” on page 17).
- The same image may be seen in different colors on multiple monitors due to their monitor-specific characteristics.
Make fine color adjustment visually when matching colors on multiple monitors.

NOTE

- The values shown in “%” or “K” are available only as reference.
- Using the “ScreenManager Pro for LCD” allows you to perform the color adjustment by using the mouse and keyboard of your PC. The adjusted status can be registered as a color data and restore the data later. (Refer to “Chapter 4 Color Adjustment” on the User’s Manual for “ScreenManager Pro for LCD”.)

● Adjustment items in each mode











According to the mode selected, the adjustable function differs.

(You can not select any function unavailable for adjustment or setting.)

The adjustments or settings made for each mode are applied to all input signals.

For the adjustment method of each function, refer to subsequent pages.

√: Adjustment available —: Invalid for adjustment





Icon	Function	FineContrast mode				
		1-User1 2-User2 3-User3	4-Text	5-Picture	6-Movie	7-sRGB
	Brightness	√	√	√	√	√
	Contrast	√	√	√	√	—
	Temperature	√	√	√	√	—
	Gamma	√	√	—	—	—
	Hue	√	√	√	√	—
	Saturation	√	√	√	√	—
	Contrast Enhancer	√	—	√	√	—
	Outline Enhancer	√	√	√	√	√
	Gain	√	—	—	—	—
	6 Colors	√	—	—	—	—
	Color Reset	√	√	√	√	√

● To adjust the brightness [Brightness]



The screen brightness is adjusted by changing the brightness of the backlight (Light source from the LCD back panel).

Adjustable range: 0 to 100%

Procedure

1. Choose <Color> from the Adjustment menu, and press .
2. Choose <Brightness> from the <Color> menu, and press .
3. Adjust the brightness with  or .
4. Press  to exit the adjustment.

NOTE





- You can also adjust the brightness using  and .
 - When you feel the image is bright even if the brightness is set to 0%, adjust the contrast.
-

● To adjust the contrast [Contrast]

The luminance of the screen is adjusted by varying the video signal level.

Adjustable range: 0 to 100%

Procedure

1. Choose <Color> from the Adjustment menu, and press .
2. Choose <Contrast> from the <Color> menu, and press .
3. Adjust the contrast with  or .
4. Press  to exit the adjustment.

NOTE





- In the contrast of 100%, every color gradation is displayed.
 - When adjusting the monitor, it is recommended to perform the brightness adjustment which may not lose the gradation characteristics, prior to the contrast adjustment.
 - Perform the contrast adjustment in the following cases.
 - When you feel the image is bright even if the brightness is set to 0%. (Set the contrast to lower than 100%).
-

● To adjust the color temperature [Temperature]

The color temperature can be adjusted. The color temperature is normally used to express the hue of “White” and/or “Black” by a numerical value. The value is expressed in degrees “K” (Kelvin). In the same way as the flame temperature, the image on the monitor is displayed reddish if the color temperature is low and is bluish if the color temperature is high. The gain preset values are set for each color temperature setting value.

Adjustable range: Native, 4000K-10000K (specified by every 500K unit, including 9300K)

Procedure

1. Choose <Color> from the Adjustment menu, and press .
2. Choose <Temperature> from the <Color> menu, and press .
3. Adjust the color temperature with  or .
4. Press  to exit the adjustment.

NOTE





- [Gain] allows you to perform more advanced adjustment (See “To adjust the gain value” on [page 22](#)).
 - If you set to [Native], the image is displayed in the preset color of the monitor (Gain: 100% for each RGB).
 - When changing the gain value, the color temperature adjusting range is changed to “User”.
-

● To adjust the gamma value [Gamma]

The gamma value can be adjusted. The luminance of the monitor varies depending on the input signal, however, the variation rate is not proportional to the input signal. To keep the balance between the input signal and the luminance of the monitor is called as “Gamma correction”.

Adjustable range: 1.8-2.6

Procedure







1. Choose <Color> from the Adjustment menu, and press .
2. Choose <Gamma> from the <Color> menu, and press .
3. Adjust the gamma value with  or .
4. Press  to exit the adjustment.

● To adjust the hue [Hue]

This function allows you to adjust the hue.

Adjustable range: -100 to 100

Procedure

1. Choose <Color> from the Adjustment menu, and press .
2. Choose <Advanced Settings> from the <Color> menu, and press .
3. Choose <Hue>, and press .
4. Adjust the hue with  or .
5. Press  to exit the adjustment.

Attention







- This function does not enable to display every color gradation.
-

● To adjust the color saturation [Saturation]

This function allows you to adjust the saturation of the color on the monitor.

Adjustable range: -100 to 100

Procedure

1. Choose <Color> from the Adjustment menu, and press .
2. Choose <Advanced Settings> from the <Color> menu, and press .
3. Choose <Saturation>, and press .
4. Adjust the saturation of the color with  or .
5. Press  to exit the adjustment.

Attention

- This function does not enable to display every color gradation.
-







NOTE

- Setting the minimum (-100) turns the image to a monochrome screen.
-

● Enable/Disable Contrast Enhancer [Contrast Enhancer]

This feature manages the brightness and gain levels of the backlight to match the image displayed while also improving the sense of contrast of images by correcting gamma values.







Procedure

1. Choose <Color> from the Adjustment menu, and press .
2. Choose <Advanced Settings> from the <Color> menu, and press .
3. Choose <Contrast Enhancer>, and press .
4. Select “On” or “Off” with  or .
5. Press  to exit the adjustment.

● To enhance the outline of the image [Outline Enhancer]

Outline Enhancer functions to emphasize outline of the images by emphasizing the color difference between pixels composing the images. This may improve the texture of the material and its feel of the images. On the contrary, it also functions to reproduce the images smoothly by gradating its outline.

Procedure







1. Choose <Color> from the Adjustment menu, and press .
2. Choose <Advanced Settings> from the <Color> menu, and press .
3. Choose <Outline Enhancer>, and press .
4. Select the display status in the range from -3 to 3 (soft to sharp) with  or  as desired.
5. Press  to exit the adjustment.

● To adjust the gain value [Gain]

Each luminance of red/green/blue composing the color is called “Gain”. The gain adjustment may change the color tone of the “White”.

Adjustable range: 0 to 100%

Procedure

1. Choose <Color> from the Adjustment menu, and press .
2. Choose <Advanced Settings> from the <Color> menu, and press .
3. Choose <Gain>, and press .
4. Choose the color for adjustment among <Red>, <Green>, or <Blue> to adjust, and press .
5. Adjust the gain with  or .
6. Press  to exit the adjustment.

NOTE









- The gain value may change depending on the value of the color temperature.
 - When changing the gain value, the color temperature adjusting range is changed to “User”.
 - This function does not enable to display every color gradation.
-

● To adjust six colors [6 Colors]

The hue and saturation can be adjusted for each of six colors: Magenta, Red, Yellow, Green, Cyan, and Blue.

Adjustable range: -100 to 100

Procedure

1. Choose <Color> from the Adjustment menu, and press .
2. Choose <Advanced Settings> from the <Color> menu, and press .
3. Choose <6 Colors>, and press .
4. Choose the color for adjustment among <Magenta>, <Red>, <Yellow>, <Green>, <Cyan>, or <Blue>, and press .
5. Select <Hue> or <Saturation>, and press .
6. Adjust the 6 colors with  or .
7. Press  to exit the adjustment.

2-4. Displaying Lower Resolutions

● To change screen size [Screen Size]

The image with the resolution other than the recommended resolution is displayed in full screen automatically. You can change the screen size by using <Screen Size> from <Screen> menu.

Menu	Function
Full (Default setting)	Displays an image in full screen. Images are distorted in some cases because the vertical rate is not equal to the horizontal rate.
Enlarged	Displays an image in full screen. In some cases, a blank horizontal or vertical border appears to equalize the vertical rate and the horizontal rate.
Normal	Displays images with the specified resolution.

Example: Image size 1280 x 1024

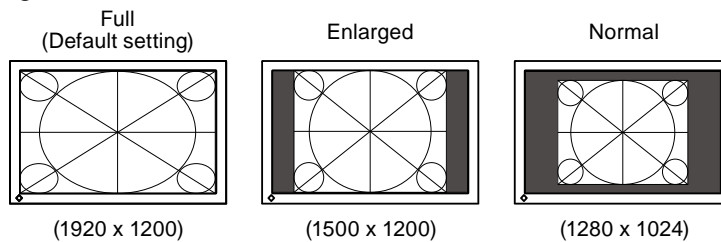

Procedure

1. Choose <Screen> from the Adjustment menu, and press .
2. Choose <Screen Size> from the <Screen> menu, and press .
3. Select “Full Screen,” “Enlarged,” or “Normal” with or .
4. Press to exit the adjustment.









Chapter 3 Setting Monitor

3-1. Enabling/Disabling Mode Selection [Mode Preset]

Allows you to select the specified modes only.

Use this function when all the display modes are not available or when keeping the display mode unchanged.

Procedure

1. Choose <Tools> from the Adjustment menu, and press .
2. Choose <Mode Preset> from the <Tools> menu, and press .
3. Select the mode to change its settings with  or , and press .
4. Select “On” or “Off” with  or .
5. Press  to exit the adjustment.







Attention



- You cannot set all the modes disable. Set at least one mode to “On”.



3-2. Locking Buttons [Key Lock]

This function allows you to lock to prevent changing the adjusted/set status.

Procedure

1. Press  to turn off the monitor.
2. Press  holding  down for at least 2 seconds to turn on the monitor.
The Optional Settings menu appears.
3. Choose <Key Lock> from the <Optional Settings> menu, and press .
4. Select “Off”, “Menu”, or “All” with  or , and press .

Settings	Buttons that can be locked
Off (Initial settings)	None (All buttons are enabled)
Menu	 button
All	All buttons excluding 

5. Select “Finish” with  or .
6. Press  to exit.
The Optional Settings menu is closed.

3-3. Setting the EIZO Logo Display [Logo]

The EIZO logo appears on the display when turning on the monitor. This function allows you to display, or not, the EIZO logo.

Procedure

1. Press **(P)** to turn off the monitor.
2. Press **(M)** holding **(P)** down at least 2 seconds to turn on the monitor.

The Optional Settings menu appears.

3. Choose <Logo> from the <Optional Settings> menu, and press **(O)**.
4. Select “On” or “Off” with **(▲)** or **(▼)**, and press **(O)**.
5. Select “Finish” with **(▲)** or **(▼)**.
6. Press **(O)** to exit the Optional Settings.

The Optional Settings menu is closed.

3-4. Setting Orientation [Orientation]

● To set the orientation of the Adjustment menu

This function allows you to change the orientation of the Adjustment menu when using the monitor screen in vertical display position. (Default settings : Landscape)

Procedure

1. Choose <Menu Settings> from the Adjustment menu, and press **(O)**.
2. Choose <Orientation> from the <Menu Settings> menu, and press **(O)**.
3. Select “Landscape” or “Portrait” with **(▲)** or **(▼)**.
4. Press **(O)** to exit the adjustment.
5. When selecting “Portrait”, turn the monitor screen 90° in clockwise direction.

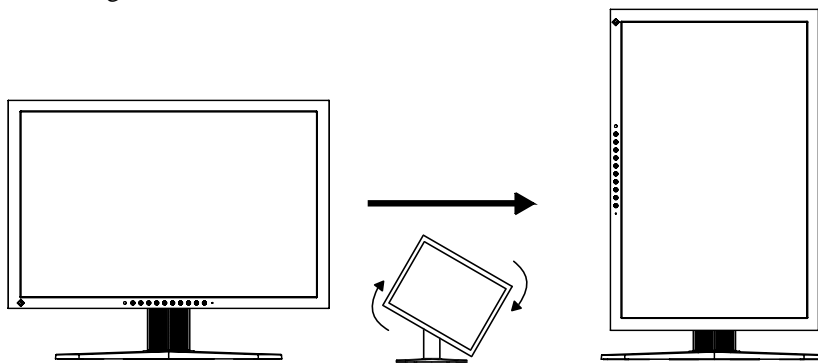

Attention

- Be sure that the cables are correctly connected.

NOTE

- For using the monitor with “Portrait” position, the graphics board supporting portrait display is required. When placing the monitor in a “Portrait” position, settings of your graphics board need to be changed. Refer to the manual of the graphics board for details.





3-5. Setting Language [Language]

This function allows you to select a language for the adjustment menu or displaying message.

Selectable languages

English/German/French/Spanish/Italian/Swedish/Japanese /Simplified Chinese/Traditional Chinese





Procedure

1. Choose <Menu Settings> menu from the Adjustment menu, and press .
2. Choose <Language> from the <Menu Settings> menu, and press .
3. Choose a language with  or .
4. Press  to exit the adjustment.

3-6. Setting the Display Position of the Adjustment Menu [Menu Position]

Adjust the menu position using the following procedure.









Procedure

1. Choose <Menu Settings> from the Adjustment menu, and press .
2. Choose <Menu Position> from the <Menu Settings> menu, and press .
3. Select a position with  or .
4. Press  to exit the adjustment.

3-7. Enable/Disable DDC/CI communication

This function allows you to enable/disable the DDC/CI communication. (page 45)

Procedure

1. Press  to turn off the monitor.
 2. Press  holding  down at least 2 seconds to turn on the monitor.
The Optional Settings menu appears.
 3. Choose <DDC/CI> from the <Optional Settings> menu, and press .
 4. Select “On” or “Off” with  or , and press .
 5. Select “Finish” with  or .
- The Optional Settings menu is closed.





NOTE

- You can check the DDC/CI setting in the <Monitor Info> menu.
-

3-8. Enable/Disable Auto Sharpness [Auto Sharpness]

By enabling Auto Sharpness outlines will be adjusted according to the displayed image which can improve its feel and texture.

Procedure

1. Choose <Tools> from the Adjustment menu, and press .
2. Choose <Auto Sharpness> from the <Tools> menu, and press .
3. Select “On” or “Off” with  or .
4. Press  to exit the adjustment.

NOTE

- The extent of adjustment depends on the set up value of [Outline Enhancer].
-

3-9. Restoring the Default Setting

There are two types of Reset. One is to reset the color adjustment only to the default settings, and the other is to reset all the settings to the default settings.

Attention

- After resetting, you cannot undo the operation.
-





NOTE

- For main default settings, refer to “Main default settings (factory settings)” on [page 41](#).
-

● To reset color adjustment values [Color Reset]

Only the adjustment values in the current mode will revert to the default settings (factory settings).

Procedure





1. Choose <Color> from the Adjustment menu, and press .
2. Choose <Color Reset> from the <Color> menu and press .
3. Select “Execute” with  or .
4. Press  to exit the adjustment.

The color adjustment values revert to the default settings.

● To reset all adjustments to the factory default settings [All Reset]

Reset all adjustments to the factory default settings.

Procedure

1. Choose <Tools> from the Adjustment menu, and press .
2. Choose <All Reset> from the <Tools> menu, and press .
3. Select “Execute” with  or .
4. Press  to exit the adjustment.

All setting values revert to the default settings.

Chapter 4 Power Saving Function

4-1. Setting the Power Saving [Power Save]

This function allows you to set the monitor into the power saving mode according to the PC status. When the monitor enters the power saving mode, no image is displayed on the screen.





Attention

- Turning off the main power switch or unplugging the power cord completely shuts off power supply to the monitor.
- Devices connected to the USB port (upstream and downstream) work when the monitor is in power saving mode or when the power button of the monitor is Off. Therefore, power consumption of the monitor varies with connected devices even in the power saving mode.

Power Save is compliant with the following standards for the respective signal inputs.

signal inputs		Standard
Analog signal		VESA DPMS
Digital signal	DVI	DVI DMPM
	DisplayPort	DisplayPort Standard V1.1a

Procedure

1. Choose <PowerManager> from the Adjustment menu, and press .
2. Choose <Power Save> from the <PowerManager> menu, and press .
3. Select “On” or “Off” with  or .
4. Press  to exit the adjustment.

Power Saving System





The monitor enters the power saving mode in conjunction with the PC settings.

PC		Monitor Power	Indicator
Operating		Operating	Blue
Power saving	STAND-BY SUSPENDED OFF	Power saving	Orange

4-2. Setting Power Indicator [Power Indicator]

The brightness of the power indicator (blue) when the screen is displayed can be adjusted (default setting is set to light up when power is turned on, and brightness is set to 4).

Procedure

1. Choose <PowerManager> from the Adjustment menu, and press .
2. Choose <Power Indicator> from the <PowerManager> menu, and press .
3. Select the indicator brightness “Off” or in the range from 1 to 7 with  or  as desired.
4. Press  to exit the adjustment.





4-3. Setting Monitor's Automatic Brightness Adjustment [Auto EcoView]

The sensor on the lower side of the monitor detects the environmental brightness to adjust the screen brightness automatically and comfortably by using the Auto EcoView function.

Attention

- Be careful not to block the sensor on the lower side of the monitor when using the Auto EcoView function.
-

Procedure





1. Choose <PowerManager> from the Adjustment menu, and press .
2. Choose <Auto EcoView> from the <PowerManager> menu, and press .
3. Select "On" or "Off" with  or .
4. Press  to exit the adjustment.

4-4. Setting the automatic power off function [Eco Timer]

This function allows you to switch the setting to turn off the monitor automatically after a specified time has passed at the power saving mode.

Adjustable range: Disable, Enable (0, 1, 2, 3, 4, 5, 10, 15, 20, 25, 30, 45 min, 1-5h)





Procedure



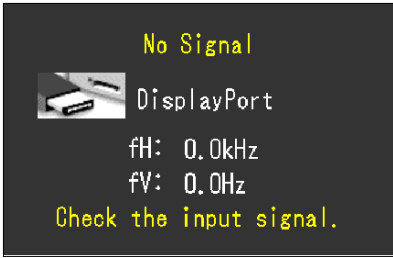

1. Choose <PowerManager> from the Adjustment menu, and press .
2. Choose <Eco Timer> from the <PowerManager> menu, and press .
3. Select "Off" or time to turn off the monitor with  or .
4. Press  to exit the adjustment.

Chapter 5 Troubleshooting

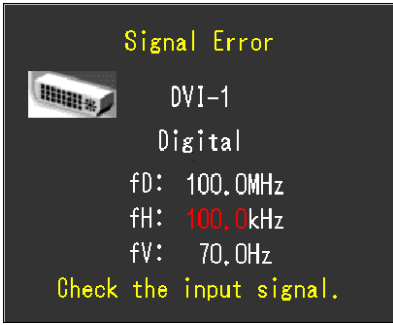
If a problem still remains after applying the suggested remedies, contact your local dealer.

- No-picture problems → See No.1 - No.2.
- Imaging problems (digital input) → See No.3 - No.8.
- Imaging problems (analog input) → See No.3 - No.12.
- Other problems → See No.13 - No.16.

Problems	Possible cause and remedy
<p>1. No picture</p> <ul style="list-style-type: none"> • Power indicator does not light. <hr/> <ul style="list-style-type: none"> • Power indicator lights blue. <hr/> <ul style="list-style-type: none"> • Power indicator lights orange. 	<ul style="list-style-type: none"> • Check whether the power cord is connected correctly. • Turn off the main power, and then turn it on again a few minutes later. • Turn the main power switch on. • Press . <hr/> <ul style="list-style-type: none"> • Set each adjusting value in [Brightness], [Contrast] and [Gain] to higher level. (page 20, 22) <hr/> <ul style="list-style-type: none"> • Switch the input signal with . • Operate the mouse or keyboard. • Check whether the PC is turned on.
<p>2. The message below appears.</p> <ul style="list-style-type: none"> • This message appears when no signal is input. Example: 	<p>This message appears when the signal is not input correctly even when the monitor functions properly.</p> <ul style="list-style-type: none"> • The message shown left may appear, because some PCs do not output the signal soon after power-on. • Check whether the PC is turned on. • Check whether the signal cable is connected properly. • Switch the input signal with .
<ul style="list-style-type: none"> • The message shows that the input signal is out of the specified frequency range. (Such signal frequency is displayed in red.) Example: 	<ul style="list-style-type: none"> • Check whether the signal setting of your PC matches the resolution and the vertical frequency settings for the monitor. (page 12) • Reboot the PC. • Select an appropriate display mode using the graphics board's utility. Refer to the manual of the graphics board for details. <p>fD : Dot Clock (Displayed only when the digital signal inputs) fH : Horizontal Frequency fV : Vertical Frequency</p>
<p>3. The screen is too bright or too dark.</p>	<ul style="list-style-type: none"> • Adjust using [Brightness] or [Contrast]. (The LCD monitor backlight has a fixed life span. When the screen becomes dark or begins to flicker, contact your local dealer.) • Turn on the Auto EcoView function. The monitor detects the environmental brightness to adjust the screen brightness automatically.

Problems	Possible cause and remedy
4. Characters are blurred	<ul style="list-style-type: none"> • Check whether the signal setting of your PC matches the resolution and the vertical frequency settings for the monitor. (page 12) • Adjust using <Outline Enhancer>. (page 22)
5. Afterimages appear	<ul style="list-style-type: none"> • Afterimages are particular to LCD monitors. Avoid displaying the same image for a long time. • Use the screen saver or power save function to avoid displaying the same image for extended periods of time.
6. Green/red/blue/white dots or defective dots remain on the screen.	<ul style="list-style-type: none"> • This is due to LCD panel characteristics and is not a failure.
7. Interference patterns or pressure marks remain on the screen.	<ul style="list-style-type: none"> • Leave the monitor with a white or black screen. The symptom may disappear.
8. Noise appears on the screen.	<ul style="list-style-type: none"> • When entering the signals of HDCP system, the normal images may not be displayed immediately.
9. Display position is incorrect. 	<ul style="list-style-type: none"> • Adjust image position using <Hor.Position> or <Ver.Position>. (page 16) • If the problem persists, use the graphics board's utility if available to change the display position.
10. Vertical bars appear on the screen or a part of the image is flickering. 	<ul style="list-style-type: none"> • Adjust using [Clock]. (page 16)
11. Whole screen is flickering or blurring. 	<ul style="list-style-type: none"> • Adjust using [Phase]. (page 16)
12. Upper part of the screen is distorted as shown below. 	<ul style="list-style-type: none"> • This is caused when both composite sync (X-OR) signal and separate vertical sync signal are input simultaneously. Select either composite signal or separate signal.
13. The adjustment menu does not appear.	<ul style="list-style-type: none"> • Check whether the operation lock function works. (page 25)
14. Mode menu does not appear.	<ul style="list-style-type: none"> • Check whether the operation lock function works. (page 25)
15. The auto adjust function does not work correctly.	<ul style="list-style-type: none"> • This function does not work when digital signal is input. • This function is intended for use on the Macintosh and on AT-compatible PC running Windows. It may not work properly in either of the following cases. It does not work properly when an image is displayed only on a part of the screen (command prompt window, for example) or when a black background (wallpaper, etc.) is in use. • This function does not work correctly with some graphics boards.

Problems	Possible cause and remedy
<p>16. The monitor connected with the USB cable is not detected. / USB devices connected to the monitor does not work.</p>	<ul style="list-style-type: none"> • Check whether the USB cable is connected correctly. (page 37) • Change the USB port to another one. If the PC or peripheral devices works correctly by changing the USB port, contact your local dealer. (Refer to the manual of the PC for details.) • Reboot the PC. • If the peripheral devices work correctly when the PC and peripheral devices are connected directly, please contact your local dealer. • Check whether the PC and OS are USB compliant. (For USB compliance of the respective devices, consult their manufacturers.) • Check the PC's BIOS setting for USB when using Windows. (Refer to the manual of the PC for details.)

Chapter 6 Reference

6-1. Attaching an Arm

The stand can be removed and replaced with an arm (or another stand) to be attached to the monitor. Use an arm or stand of EIZO option.

Attention

- When attaching an arm or stand, follow the instructions of their user's manual.
 - When using another manufacturer's arm or stand, confirm the following in advance and select one conforming to the VESA standard.
 - Clearance between the screw holes: 100 mm × 100 mm
 - Thickness of plate: 2.6 mm
 - Strong enough to support weight of the monitor unit (except the stand) and attachments such as cables.
- Use the screws as described below.
- SX2262W
The screws fixing the stand to the monitor
 - SX2462W
The screws supplied with this monitor (M4 × 12mm)
- When using an arm or stand, attach it to meet the following tilt angles of the monitor.
 - Up 45 degrees, down 45 degrees (horizontal display, and vertical display rotated 90 degrees clockwise)
 - Connect the cables after attaching an arm or a stand.
 - Do not adjust the height of the stand removed from the monitor. When adjusted without attached monitor, it causes the personnel injury or the damaged to the stand.
 - Since the monitor and arm or stand are so heavy, dropping them may result in injury or equipment damage.
 - If you need to remove the SX2262W, turn the panel on the monitor to the left and right a little so that the four screws positioned under the stand are visible. Then, unscrew the four screws.

[Attachment Procedure]

1 Lay the LCD monitor on a soft cloth spread over on a stable surface with the panel surface facing down.

2 Remove the stand.

Prepare a screwdriver. Unscrew the four screws securing the unit and the stand with the screwdriver.

3 Attach the monitor to the arm or stand.

Secure the monitor to the arm or stand using the screws specified in the user's manual of the arm or stand.

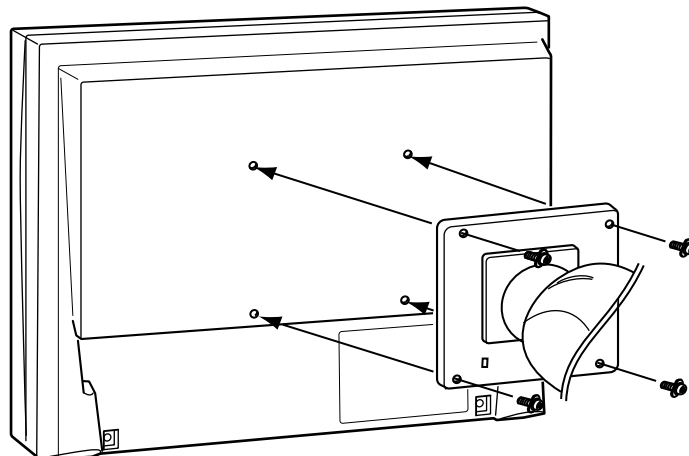

6-2. Connecting More than Two PCs to the Monitor

More than two PCs can be connected to the monitor through the DVI-I and the DisplayPort connector on the back of the monitor.

Connection examples

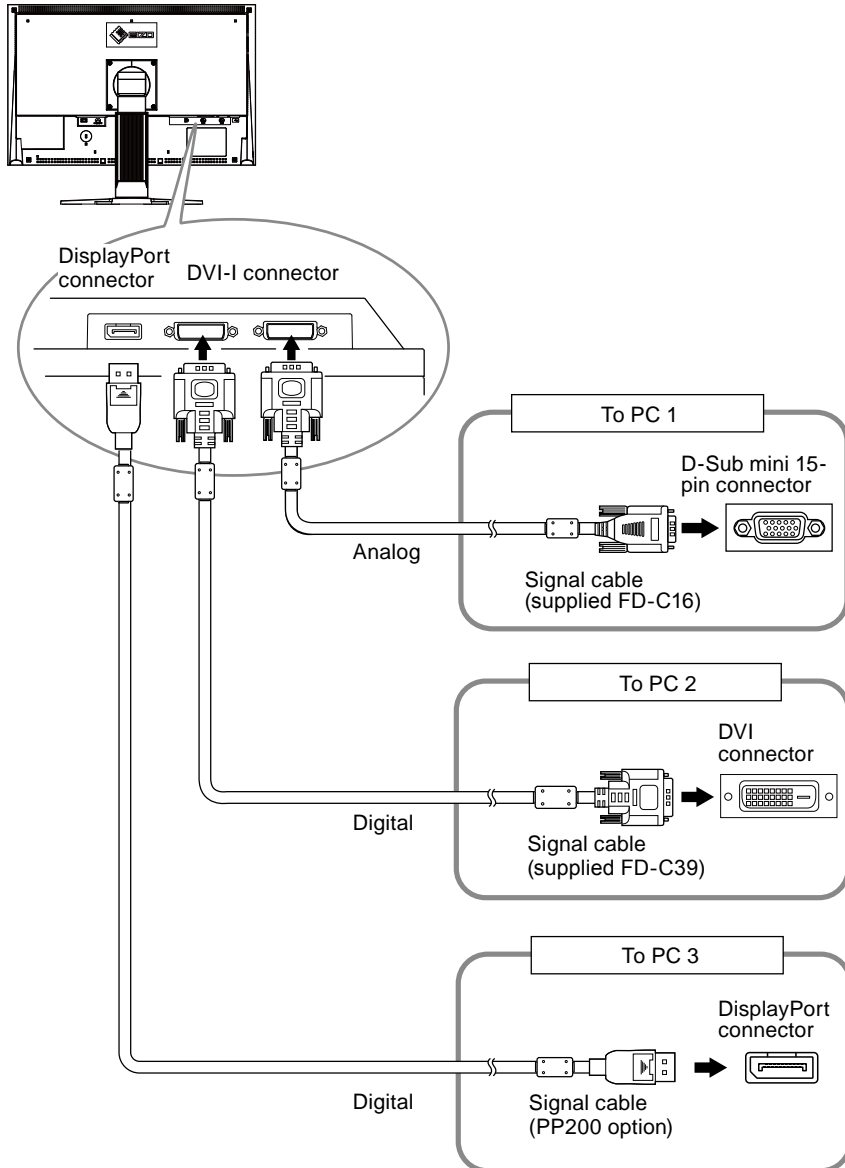

● To switch the input signal

The input signal switches each time **S** is pressed.

When the signal is switched, the active input port name appears at the top right corner of the screen.

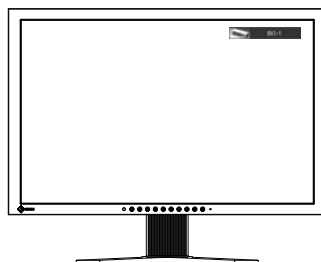

● To set input signal selection [Input Selection]

The monitor recognizes the connector through which PC signals are input. When a PC is turned off or enters the powersaving mode, the monitor automatically displays another signal.

Setting	Function
Auto	When a PC is turned off or enters the powersaving mode, the monitor automatically displays another signal.
Manual	The monitor detects only the PC's signals currently displaying automatically. Select an active input signal with S .

Procedure

1. Choose <Tools> from the Adjustment menu, and press **○**.
2. Choose <Input Selection> from the <Tools> menu, and press **○**.
The <Input Selection> menu appears.
3. Select "Auto" or "Manual" with **▲** or **▼**.
4. Press **○** to exit the adjustment.

Attention

- When "Auto" is selected for <Input Selection>, the monitor's power-saving function works only when all PCs are in the power-saving mode
-

6-3. Making Use of USB (Universal Serial Bus)

This monitor has a hub compatible with USB. Connected to a PC compatible with USB or another USB hub, this monitor functions as a USB hub allowing connection to peripheral USB devices.

● Required System Environment

1. A PC equipped with a USB port or another USB hub connected to a USB compatible PC
2. Windows 2000/XP/Vista/7 or Mac OS 9.2.2 and Mac OS X 10.2 or later
3. EIZO USB cable (MD-C93)

Attention

- This monitor may not work depending on PC, OS or peripheral devices to be used. For USB compatibility of peripheral devices, contact their manufactures.
 - Devices connected to the USB port (upstream and downstream) work when the monitor is in power saving mode or when the power button of the monitor is Off. Therefore, power consumption of the monitor varies with connected devices even in the power saving mode.
 - When the main power switch is Off, device connected to the USB port will not operate.
-

● Connection Procedure (Setup of USB Function)

1. Connect the monitor first to a PC using the signal cable, and run the PC.
2. Connect the supplied USB cable between the downstream USB port of a USB compatible PC (or another USB hub) and the monitor's upstream USB port.
The USB hub function is set up automatically upon connection of the USB cable.
3. Connect the peripheral USB device to the USB port (downstream) of the monitor.

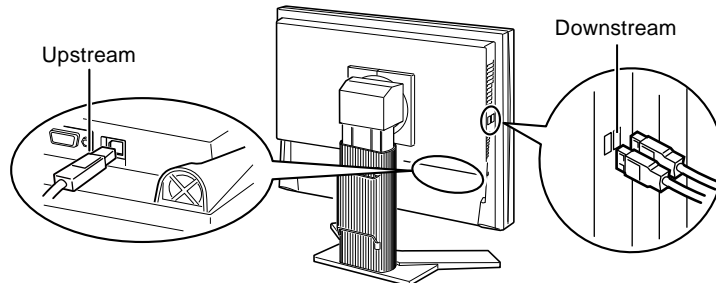

6-4. Displaying Monitor Information

● Displaying monitor information by pressing

This indicator shows the power saving ratio, power reduction and CO² reduction as a result of the brightness of the monitor.

(Example)





NOTE

- Power reduction: the backlight's reduction of electricity consumption as a result of the adjusted brightness value
- CO² reduction: converted from the "Power reduction" value, this is an estimate of the quantity of CO² emissions reduced when using the monitor for 1 hour.

* The numeric value is a result of a calculation based on a default value (0.000555 t -CO₂/kWh) determined by a ministerial ordinance (2006, Ministry of Economy, Trade and Industry, Ministry of Environment, civil code article 3) and may differ depending on country and year.

● Displaying signal information [Signal Info]

This function displays the information about the current input signals displayed.

1. Choose <Tools> from the Adjustment menu, and press .
2. Choose <Signal Info> from the <Tools> menu, and press .

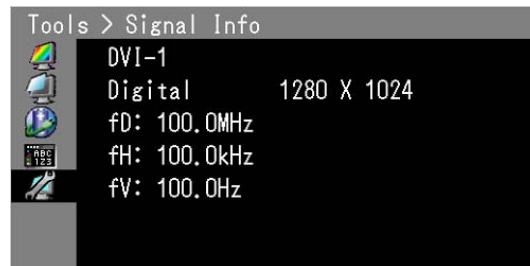

The Signal Info screen appears.

(Example)



● Displaying monitor information [Monitor Info]

This function displays the information about the monitor.

1. Choose <Tools> from the Adjustment menu, and press .
2. Choose <Monitor Info> from the <Tools> menu, and press .

The Monitor Info screen appears.

(Example)

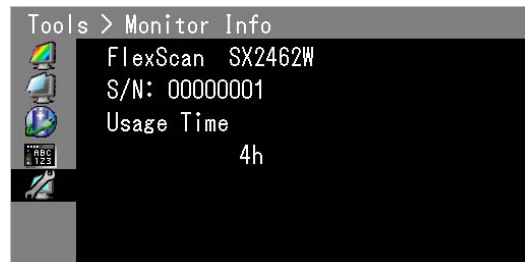

Attention

- The usage time is not always "0" due to factory inspection when you purchase the monitor.

6-5. Specifications

SX2262W

LCD Panel	Size	22.0-inch (560 mm) TFT color LCD
	Surface treatment	Anti-Glare Hard Coating
	Surface hardness	3H
	Viewing angle	Viewing angle : Horizontal 178°, Vertical 178° (CR:10 or more)
	Dot Pitch	0.247 mm
	Response Time	Approx. 12ms
Horizontal Scan Frequency	Analog	31-76 kHz
	Digital	31-76 kHz
Vertical Scan Frequency	Analog	49-86 Hz (Non-interlace)
	Digital	59-61 Hz (Non-interlace) (VGA TEXT: 69-71 Hz)
Resolution		1920 dots × 1200 lines
Max. Dot Clock	Analog	170 MHz
	Digital	164.5 MHz
Max. Display Color		Approx. 1073.74 million colors (DisplayPort 10bit)
Display Area (H × V)		473.76 mm × 296.1 mm
Power Supply		100-120 VAC ±10%, 50/60Hz 0.9A 200-240 VAC ±10%, 50/60Hz 0.45A
Power Consumption	Screen Display On	90W or less (with USB load) 80W or less (without USB load)
	Power saving mode	0.9W or less (for DVI-I (Analog) single signal input, without USB load, [Input Selection] : "Manual")
	Power button Off	0.7W or less (without USB load)
	Main Power switch Off	0W
Input Signal Connector		DVI-I connector (Applicable to HDCP) × 2
		DisplayPort (Standard V1.1a, applicable to HDCP)
Analog Input Signal (Sync)		Separate, TTL, positive/ negative Composite, TTL, positive/ negative
Analog Input Signal (Video)		Analog, Positive (0.7Vp-p/75Ω)
Digital Signal (DVI) Transmission System		TMDS (Single Link)
Analog Input Signal Video Signal Memory (Max.)		45 (preset: 9)
Plug & Play		Analog / Digital (DVI-I) : VESA DDC 2B / EDID structure 1.3 Digital (DisplayPort) : VESA DisplayPort / EDID structure 1.4
Dimensions	Main unit	511 mm (20.1 inch) × 347.5-521.5 mm (13.7 – 20.5 inch) × 240.5 mm (9.5 inch)
	Main unit (without stand)	511 mm (20.1 inch) × 333 mm (13.1 inch) × 85 mm (3.35 inch)
Mass	Main unit	Approx. 9.6 kg (21.2 lbs.)
	Main unit (without stand)	Approx. 6.6 kg (14.6 lbs.)
Movable range	Tilt	30° Up, 0° Down
	Swivel	172° Right, 172° Left
	Adjustable height	225 mm (8.9 inch) (174 mm (6.9 inch) when Tilt is 0°)
	Rotation	90° (clockwise)

Environmental Conditions	Temperature	Operating temperature: 0 °C - 35 °C (32 °F - 95 °F) Storage temperature: -20 °C - 60 °C (-4 °F - 140 °F)
	Humidity	Operating humidity: 20% - 80% R.H. (no condensation) Storage humidity: 10% - 80% R.H. (no condensation)
	Pressure	Operating: 700 to 1,060 hPa Storage: 200 to 1,060 hPa
USB	Standard	USB Specification Revision 2.0
	Port	Upstream port × 1, Downstream port × 2
	Communication Speed	480 Mbps (high), 12 Mbps (full), 1.5 Mbps (low)
	Supply current	Downstream: Max. 500mA/1 port

SX2462W

LCD Panel	Size	24.1-inch (610 mm) TFT color LCD
	Surface treatment	Hard Coating
	Surface hardness	3H
	Viewing angle	Viewing angle : Horizontal 178°, Vertical 178° (CR:10 or more)
	Dot Pitch	0.270 mm
	Response Time	Approx. 13ms
Horizontal Scan Frequency	Analog	31-76 kHz
	Digital	31-76 kHz
Vertical Scan Frequency	Analog	49-86 Hz (Non-interlace)
	Digital	59-61 Hz (Non-interlace) (VGA TEXT: 69-71 Hz)
Resolution		1920 dots × 1200 lines
Max. Dot Clock	Analog	170 MHz
	Digital	164.5 MHz
Max. Display Color		Approx. 1073.74 million colors (DisplayPort 10bit)
Display Area (H × V)		518.4 mm × 324.0 mm
Power Supply		100-120 VAC ±10%, 50/60Hz 1.0A 200-240 VAC ±10%, 50/60Hz 0.5A
Power Consumption	Screen Display On	95W or less (with USB load) 85W or less (without USB load)
	Power saving mode	0.9W or less (for DVI-I (Analog) single signal input, without USB load, [Input Selection] : "Manual")
	Power button Off	0.7W or less (without USB load)
	Main Power switch Off	0W
Input Signal Connector		DVI-I connector (Applicable to HDCP) × 2
		DisplayPort (Standard V1.1a, applicable to HDCP)
Analog Input Signal (Sync)		Separate, TTL, positive/ negative Composite, TTL, positive/ negative
Analog Input Signal (Video)		Analog, Positive (0.7Vp-p/75Ω)
Digital Signal (DVI) Transmission System		TMDS (Single Link)
Analog Input Signal Video Signal Memory (Max.)		45 (preset: 9)
Plug & Play		Analog / Digital (DVI-I) : VESA DDC 2B / EDID structure 1.3 Digital (DisplayPort) : VESA DisplayPort / EDID structure 1.4

Dimensions	Main unit	566 mm (22.3 inch) × 456-538 mm (18.0 – 21.2 inch) × 230 mm (9.1 inch)
	Main unit (without stand)	566 mm (22.3 inch) × 367 mm (14.4 inch) × 85 mm (3.4 inch)
Mass	Main unit	Approx. 10.7 kg (23.6 lbs.)
	Main unit (without stand)	Approx. 7.1 kg (15.7 lbs.)
Movable range	Tilt	40° Up, 0° Down
	Swivel	35° Right, 35° Left
	Adjustable height	82 mm (3.23 inch)
	Rotation	90° (clockwise)
Environmental Conditions	Temperature	Operating temperature: 0 °C - 35 °C (32 °F - 95 °F) Storage temperature: -20 °C - 60 °C (-4 °F - 140 °F)
	Humidity	Operating humidity: 20% - 80% R.H. (no condensation) Storage humidity: 10% - 80% R.H. (no condensation)
	Pressure	Operating: 700 to 1,060 hPa Storage: 200 to 1,060 hPa
USB	Standard	USB Specification Revision 2.0
	Port	Upstream port × 1, Downstream port × 2
	Communication Speed	480 Mbps (high), 12 Mbps (full), 1.5 Mbps (low)
	Supply current	Downstream: Max. 500mA/1 port

Main default settings (factory settings)

FineContrast	User1
Power Save	On
Input Selection	Manual
Screen Size	Full
Auto EcoView	On
Outline Enhancer	0
Menu Position	Center
Eco Timer	Off
Language	English

Outside Dimensions

SX2262W

Unit: mm (inch)

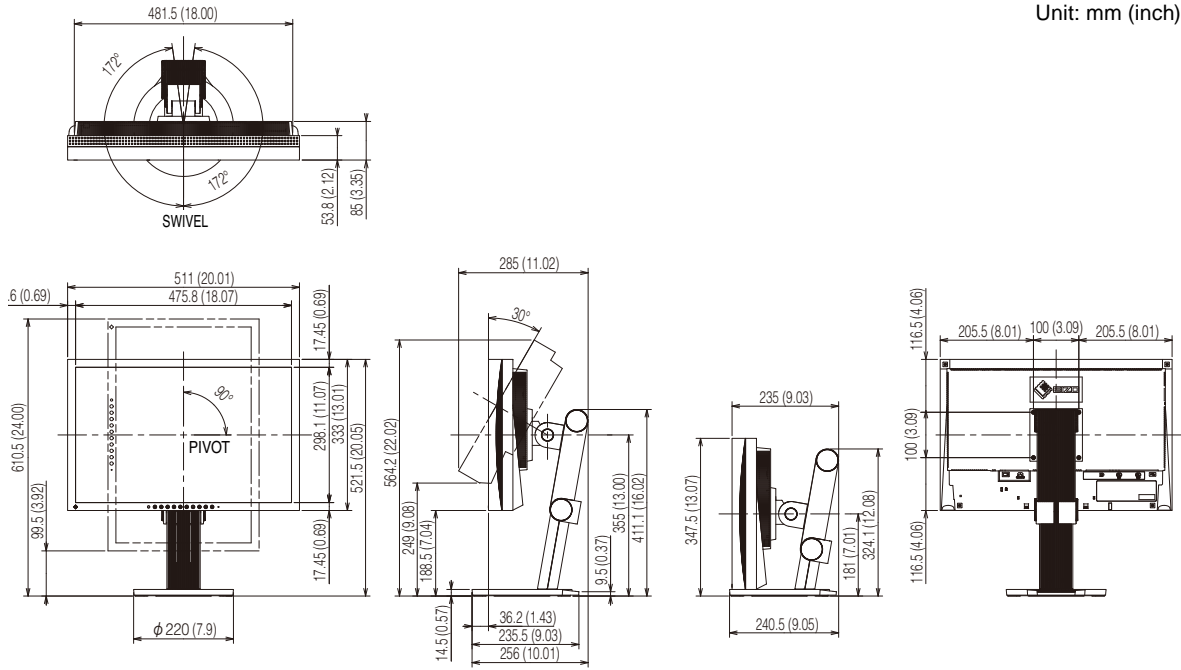

SX2462W

Unit: mm (inch)

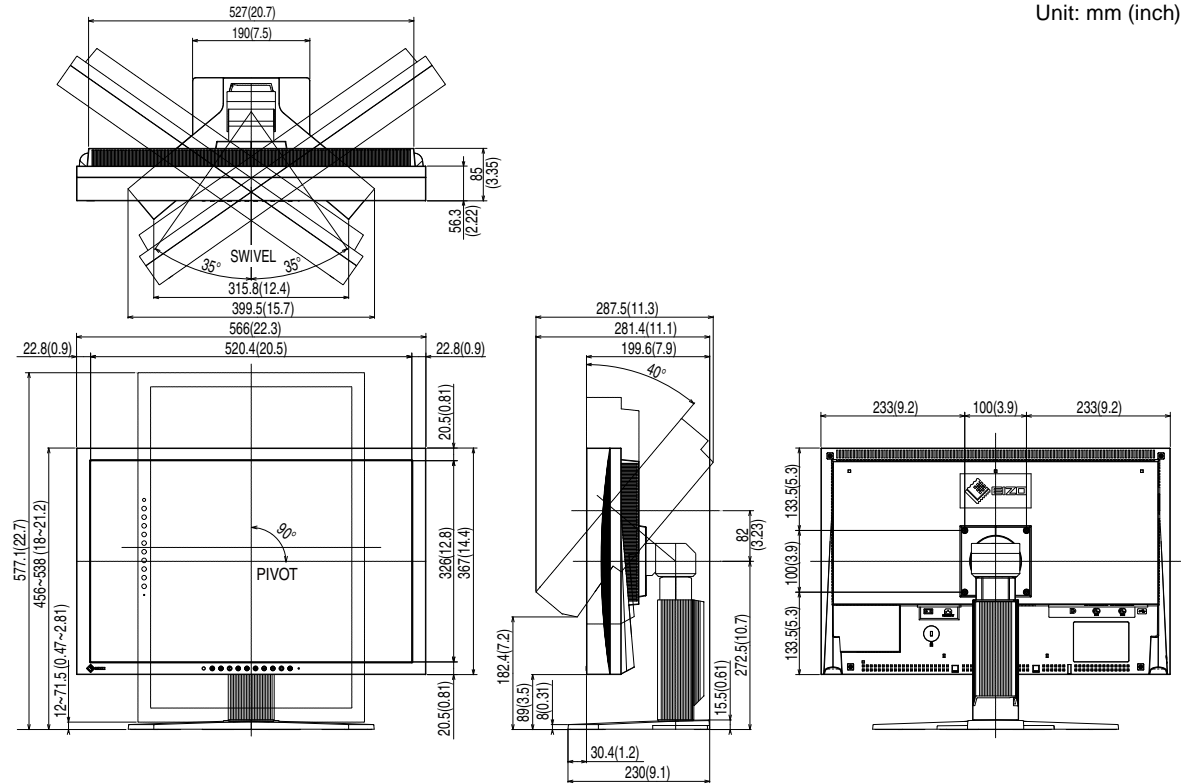

Connector Pin Assignment

- DVI-I connector

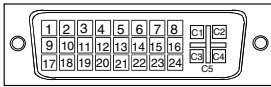

Pin No.	Signal	Pin No.	Signal	Pin No.	Signal
1	T.M.D.S. Data 2-	11	T.M.D.S. Data1/3 Shield	21	NC*
2	T.M.D.S. Data 2+	12	NC*	22	T.M.D.S. Clock shield
3	T.M.D.S. Data2/4 Shield	13	NC*	23	T.M.D.S. Clock+
4	NC*	14	+5V Power	24	T.M.D.S. Clock-
5	NC*	15	Ground (return for +5V, Hsync, and Vsync)	C1	Analog Red
6	DDC Clock (SCL)	16	Hot Plug Detect	C2	Analog Green
7	DDC Data (SDA)	17	T.M.D.S. Data0-	C3	Analog Blue
8	Analog Vertical Sync	18	T.M.D.S. Data0+	C4	Analog Horizontal Sync
9	T.M.D.S. Data1-	19	T.M.D.S. Data0/5 Shield	C5	Analog Ground(analog R,G,&B return)
10	T.M.D.S. Data1+	20	NC*		

(NC*: No Connection)

- DisplayPort connector

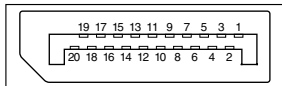

Pin No.	Signal	Pin No.	Signal	Pin No.	Signal
1	ML Lane3-	8	Ground	15	AUX CH+
2	Ground	9	ML Lane1+	16	Ground
3	ML Lane3+	10	ML Lane0-	17	AUX CH-
4	ML Lane2-	11	Ground	18	Hot Plug Detect
5	Ground	12	ML Lane0+	19	Return
6	ML Lane2+	13	CONFIG1	20	DP PWR
7	ML Lane1-	14	CONFIG2		

- USB port

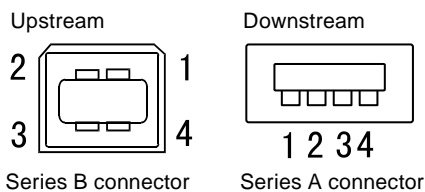

Contact No.	Signal	Remarks
1	VCC	Cable power
2	- Data	Serial data
3	+ Data	Serial data
4	Ground	Cable ground

Accessories List

Cleaning Kit	EIZO "ScreenCleaner"
Signal Cable	PP200
Speaker Unit	i•Sound L3

For the latest information about the accessories, refer to our web site. <http://www.eizo.com>

6-6. Glossary

Clock

The analog input monitor needs to reproduce a clock of the same frequency as the dot clock of the graphics system in use, when the analog input signal is converted to a digital signal for image display. This is called clock adjustment. If the clock pulse is not set correctly, some vertical bars appear on the screen.

DDC/CI (Display Data Channel/Command Interface)

VESA provides the standardization for the interactive communication of the setting information, etc. between a PC and the monitor.

DisplayPort

VESA provides the digital interface standard for the digital display device. DisplayPort can transfer the video signal up to 16 bits for each channel of RGB, and the audio signal too. (This monitor supports the 8-bit video signal only.)

DVI (Digital Visual Interface)

DVI is a digital interface standard. DVI allows direct transmission of the PC's digital data without loss. This adopts the TMDS transmission system and DVI connectors. There are two types of DVI connectors. One is a DVI-D connector for digital signal input only. The other is a DVI-I connector for both digital and analog signal inputs.

DVI DMPM (DVI Digital Monitor Power Management)

DVI DMPM is a digital interface power-saving function. The "Monitor ON (operating mode)" and "Active Off (power-saving mode)" are indispensable for DVI DMPM as the monitor's power mode.

Gain

This is used to adjust each color parameter for red, green and blue. An LCD monitor displays the color by the light passing through the panel color filter. Red, green and blue are the three primary colors. All the colors on the screen are displayed by combining these three colors. The color tone can be changed by adjusting the light intensity (volume) passing through each color's filter.

Gamma

Generally, the monitor brightness varies nonlinearly with the input signal level, which is called "Gamma Characteristic". A small gamma value produces a low-contrast image, while a large gamma value produces a highcontrast image.

HDCP (High-bandwidth Digital Contents Protection)

Digital signal coding system developed to copy-protect the digital contents, such as video, music, etc. This helps to transmit the digital contents safely by coding the digital contents sent via DVI terminal on the output side and decoding them on the input side. Any digital contents cannot be reproduced if both of the equipments on the output and input sides are not applicable to HDCP system.

Phase

Phase means the sampling timing to convert the analog input signal to a digital signal. Phase adjustment is made to adjust the timing. It is recommended that phase adjustment be made after the clock is adjusted correctly.

Range Adjustment

Range adjustment controls the signal output levels to display every color gradation. It is recommended that range adjustment be made before color adjustment.

Resolution

The LCD panel consists of numerous pixels of specified size, which are illuminated to form images. This monitor consists of 1920 horizontal pixels and 1200 vertical pixels. At a resolution of 1920 x 1200, all pixels are illuminated as a full screen (1:1).

sRGB (Standard RGB)

International standard for “color reproduction and color space” among peripheral devices (such as monitors, printers, digital cameras, scanners). sRGB allows Internet users to closely match colors as a simple color matching means for the Internet use.

Temperature

Color temperature is a method to measure the white color tone, generally indicated in degrees Kelvin. The screen becomes reddish at a low temperature, and bluish at a high temperature, like the flame temperature.

5000K: Slightly reddish white

6500K: Warm white like paper white

9300K: Slightly bluish white

TMDS (Transition Minimized Differential Signaling)

A signal transmission system for digital interface.

VESA DPMS (Video Electronics Standards Association - Display Power Management Signaling)

VESA provides the standardization of signals from PC (graphics board) for power saving of PC monitors. DPMS defines the signal status between PC and monitor.

6-7. Preset Timing

The following table shows factory preset video timing (for analog signal only).

Attention

- Display position may be deviated depending on the PC connected, which may require screen adjustment using Adjustment menu.
- If a signal other than those listed in the table is input, adjust the screen using the Adjustment menu. However, screen display may still be incorrect even after the adjustment.
- When interlace signals are used, the screen cannot be displayed correctly even after screen adjustment using the Adjustment menu.

Resolution	Applicable signal	Frequency			Polarity	
		Dot clock: MHz	Horizontal: kHz	Vertical: Hz	Horizontal	Vertical
640 × 480	VGA	25.18	31.47	59.94	Negative	Negative
720 × 400	VGA TEXT	28.32	31.47	70.09	Negative	Positive
800 × 600	VESA	40.00	37.88	60.32	Positive	Positive
1024 × 768	VESA	65.00	48.36	60.00	Negative	Negative
1280 × 960	VESA	108.00	60.00	60.00	Positive	Positive
1280 × 1024	VESA	108.00	63.98	60.02	Positive	Positive
1600 × 1200	VESA	161.99	75.00	60.00	Positive	Positive
1680 × 1050	VESA CVT	146.25	65.29	59.95	Negative	Positive
1920 × 1200	VESA CVT RB	154.00	74.04	59.95	Positive	Negative



Congratulations!

The display you have just purchased carries the TCO'03 Displays label. This means that your display is designed, manufactured and tested according to some of the strictest quality and environmental requirements in the world. This makes for a high performance product, designed with the user in focus that also minimizes the Impact on our natural environment.

Some of the features of the TCO'03 Display requirements:

Ergonomics

- Good visual ergonomics and image quality in order to improve the working environment for the user and to reduce sight and strain problems. Important parameters are luminance, contrast, resolution, reflectance, colour rendition and image stability.

Energy

- Energy-saving mode after a certain time - beneficial both for the user and environment
- Electrical safety

Emissions

- Electromagnetic fields
- Noise emissions

Ecology

- The products must be prepared for recycling and the manufacturer must have a certified environmental management system such as EMAS or ISO 14000
- Restrictions on
 - chlorinated and brominated flame retardants and polymers
 - heavy metals such as cadmium, mercury and lead.

The requirements included in this label have been developed by TCO Development in co-operation with scientists, experts, users as well as manufacturers all over the world. Since the end of the 1980s TCO has been involved in influencing the development of IT equipment in a more user-friendly direction. Our labeling system with displays in 1992 and is now requested by users and IT-manufacturers all over the world.

For more information, please visit
www.tcodevelopment.com

For U.S.A. , Canada, etc. (rated 100-120 Vac) Only

FCC Declaration of Conformity

We, the Responsible Party

EIZO NANAOTECHNOLOGIES INC.

5710 Warland Drive, Cypress, CA 90630

Phone: (562) 431-5011

declare that the product

Trade name: EIZO

Model: FlexScan SX2262W / SX2462W

is in conformity with Part 15 of the FCC Rules. Operation of this product is subject to the following two conditions: (1) this device may not cause harmful interference, and (2) this device must accept any interference received, including interference that may cause undesired operation.

This equipment has been tested and found to comply with the limits for a Class B digital device, pursuant to Part 15 of the FCC Rules. These limits are designed to provide reasonable protection against harmful interference in a residential installation. This equipment generates, uses, and can radiate radio frequency energy and, if not installed and used in accordance with the instructions, may cause harmful interference to radio communications. However, there is no guarantee that interference will not occur in a particular installation. If this equipment does cause harmful interference to radio or television reception, which can be determined by turning the equipment off and on, the user is encouraged to try to correct the interference by one or more of the following measures.

- * Reorient or relocate the receiving antenna.
- * Increase the separation between the equipment and receiver.
- * Connect the equipment into an outlet on a circuit different from that to which the receiver is connected.
- * Consult the dealer or an experienced radio/TV technician for help.

Changes or modifications not expressly approved by the party responsible for compliance could void the user's authority to operate the equipment.

Note

Use the attached specified cable below or EIZO signal cable with this monitor so as to keep interference within the limits of a Class B digital device.

- AC Cord
- Shielded Signal Cable (Enclosed)

Canadian Notice

This Class B digital apparatus complies with Canadian ICES-003.

Cet appareil numérique de la classe B est conforme à la norme NMB-003 du Canada.

Hinweise zur Auswahl des richtigen Schwenkarms für Ihren Monitor

Dieser Monitor ist für Bildschirmarbeitsplätze vorgesehen. Wenn nicht der zum Standardzubehör gehörige Schwenkarm verwendet wird, muss statt dessen ein geeigneter anderer Schwenkarm installiert werden. Bei der Auswahl des Schwenkarms sind die nachstehenden Hinweise zu berücksichtigen:

Der Standfuß muß den nachfolgenden Anforderungen entsprechen:

- a) Der Standfuß muß eine ausreichende mechanische Stabilität zur Aufnahme des Gewichtes vom Bildschirmgerät und des spezifizierten Zubehörs besitzen. Das Gewicht des Bildschirmgerätes und des Zubehörs sind in der zugehörigen Bedienungsanleitung angegeben.
- b) Die Befestigung des Standfusses muß derart erfolgen, daß die oberste Zeile der Bildschirmanzeige nicht höher als die Augenhöhe eines Benutzers in sitzender Position ist.
- c) Im Fall eines stehenden Benutzers muß die Befestigung des Bildschirmgerätes derart erfolgen, daß die Höhe der Bildschirmmitte über dem Boden zwischen 135 – 150 cm beträgt.
- d) Der Standfuß muß die Möglichkeit zur Neigung des Bildschirmgerätes besitzen (max. vorwärts: 5°, min. nach hinten $\geq 5^\circ$).
- e) Der Standfuß muß die Möglichkeit zur Drehung des Bildschirmgerätes besitzen (max. $\pm 180^\circ$). Der maximale Kraftaufwand dafür muß weniger als 100 N betragen.
- f) Der Standfuß muß in der Stellung verharren, in die er manuell bewegt wurde.
- g) Der Glanzgrad des Standfusses muß weniger als 20 Glanzeinheiten betragen (seidenmatt).
- h) Der Standfuß mit Bildschirmgerät muß bei einer Neigung von bis zu 10° aus der normalen aufrechten Position kippstabil sein.

Hinweis zur Ergonomie :

Dieser Monitor erfüllt die Anforderungen an die Ergonomie nach EK1-ITB2000 mit dem Videosignal, 1920 × 1200, Digital Eingang und mindestens 60,0 Hz Bildwiederholfrequenz, non interlaced. Weiterhin wird aus ergonomischen Gründen empfohlen, die Grundfarbe Blau nicht auf dunklem Untergrund zu verwenden (schlechte Erkennbarkeit, Augenbelastung bei zu geringem Zeichenkontrast.)

„Maschinenlärminformations-Verordnung 3. GPSGV:

Der höchste Schalldruckpegel beträgt 70 dB(A) oder weniger gemäss EN ISO 7779“

关于电子信息产品污染控制标识



本标识根据「电子信息产品污染控制管理办法」，适用于在中华人民共和国销售的电子信息产品。标识中央的数字为环保使用期限的年数。只要您遵守该产品相关的安全及使用注意事项，在自制造日起算的年限内，不会产生对环境污染或人体及财产的影响。上述标识粘贴在机器背面。

•有毒有害物质或元素的名称及含量

部件名称	有毒有害物质或元素					
	铅 (Pb)	汞 (Hg)	镉 (Cd)	六价铬 (Cr (VI))	多溴联苯 (PBB)	多溴二苯醚 (PBDE)
印刷电路板	×	○	○	○	○	○
机箱	○	○	○	○	○	○
液晶显示器	×	×	○	○	○	○
其他	×	○	○	○	○	○

○：表示该有毒有害物质在该部件所有均质材料中的含量均在 SJ/T 11363-2006 规定的限量要求以下。
 ×：表示该有毒有害物质至少在该部件的某一均质材料中的含量超出 SJ/T 11363-2006 规定的限量要求。
 （企业可在此处，根据实际情况对上表中打“×”的技术原因进行进一步说明）



EIZO NANO CORPORATION

153 Shimokashiwano, Hakusan, Ishikawa 924-8566 Japan
Phone: +81 76 277 6792 Fax: +81 76 277 6793

EIZO EUROPE AB

Lovangsvagen 14 194 61, Upplands Väsby, Sweden
Phone: +46 8 594 105 00 Fax: +46 8 590 91 575

<http://www.eizo.com>

2nd Edition-November, 2009

03V22855B1
(U.M-SX2462W)